

Rev #		
Rev #		

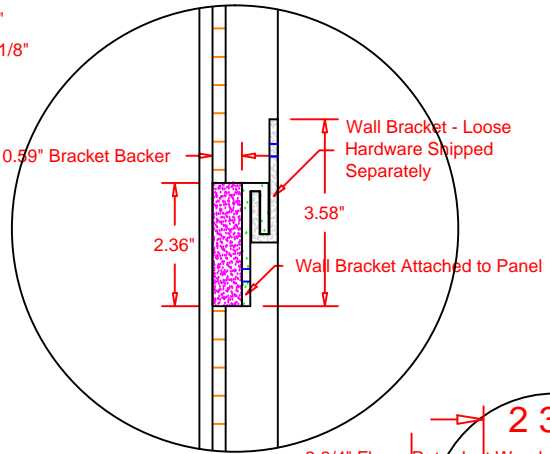

Detail A

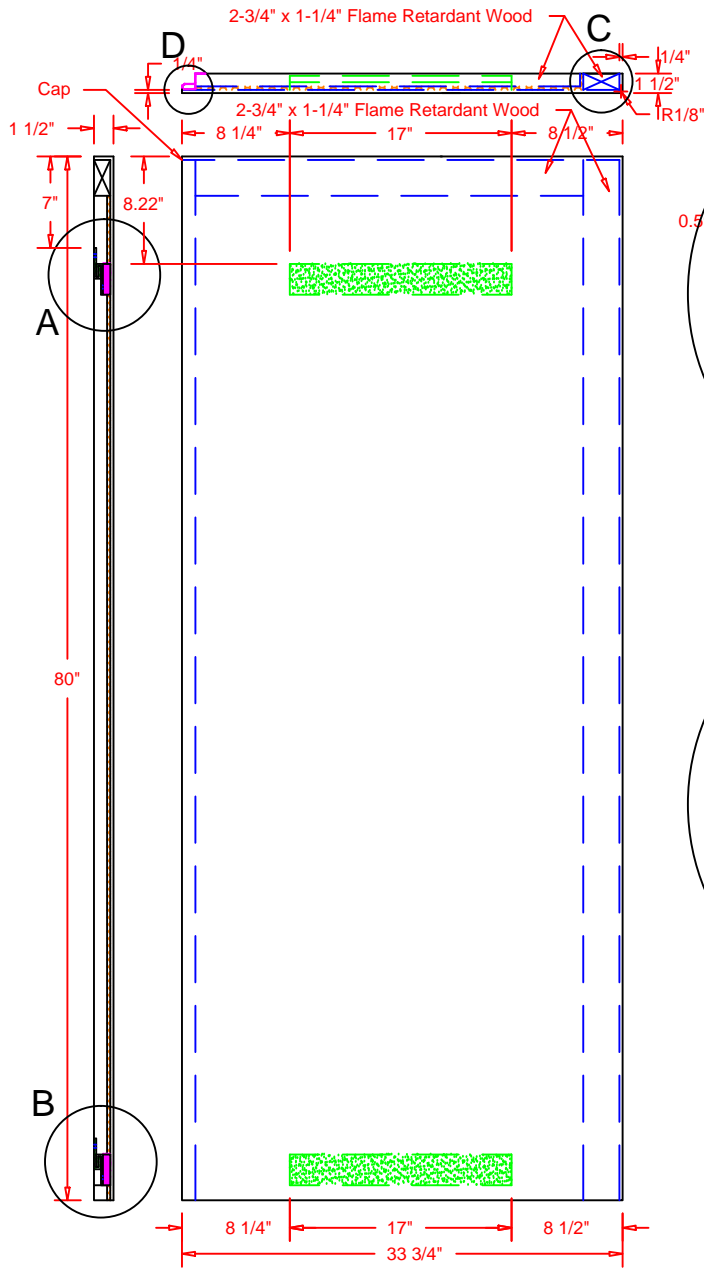
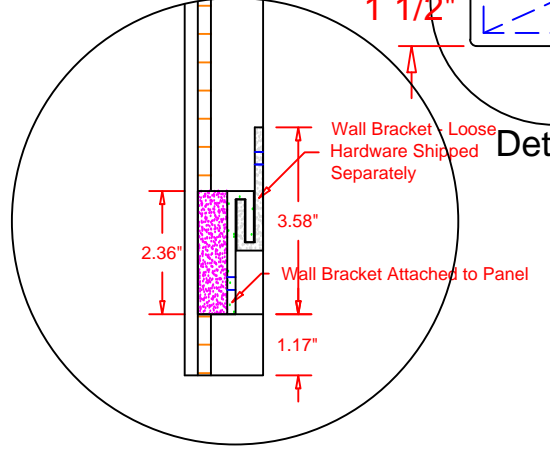

Detail B

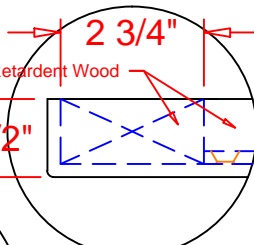

Detail C

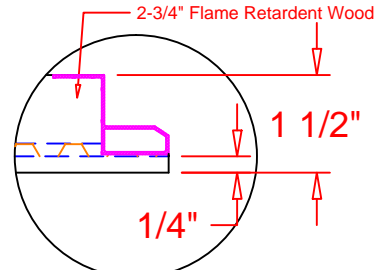

Detail D

transolid™
 400 Dietz Road
 Warren, OH 44482
 330-393-6624
 FAX 330-399-4426
 www.transolid.com

Part Number:	DE348R		
Description:	34" x 48" - Right Wall		
Date Drawn:	12/05/13	Weight:	None
		Scale:	None
Drawn By:	Daniel Hollifield		Revised By:
Approved By:			Date Revised:

Customer Approval: _____ Date: _____
 Path: @Engineering12 Commercial